

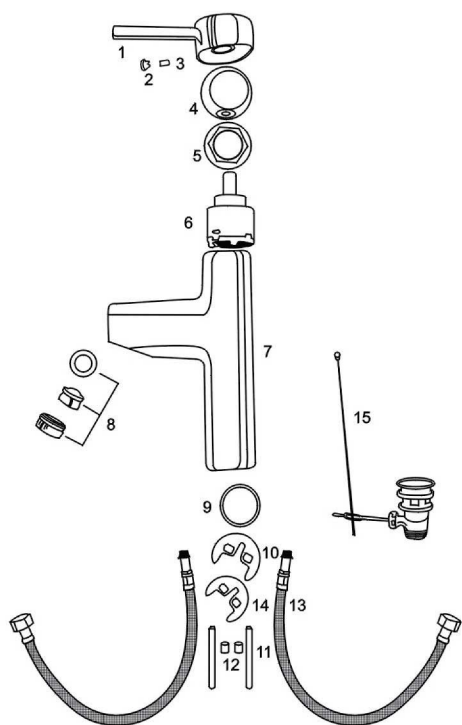















Mitigeur Lavabo / Single Lavatory Mixer

Réf. : 639993



Numéro	Photo	Quantité	SAV RÉF	Cochez la case	Quantité requise
1	 x1	1	56832501	<input type="checkbox"/>	
2	 x1	1	56832502	<input type="checkbox"/>	
3	 x1	1	56832503	<input type="checkbox"/>	
4	 x1	1	56832504	<input type="checkbox"/>	
5	 x1	1	56832505	<input type="checkbox"/>	
6	 x1	1	56832506	<input type="checkbox"/>	
7	 x1	1	56832507	<input type="checkbox"/>	
8	 x1	1	56832508	<input type="checkbox"/>	
9	 x1	1	56832509	<input type="checkbox"/>	
10	 x1	1	56832510	<input type="checkbox"/>	
11	 x2	2	56832511	<input type="checkbox"/>	
12	 x2	2	56832512	<input type="checkbox"/>	
13	 x2	2	56832513	<input type="checkbox"/>	
14	 x1	1	56832514	<input type="checkbox"/>	
15	 x1	1	56832515	<input type="checkbox"/>	

Réf. : 639993

Importé de chine par MB LOG

SERVICE CONSOMMATEURS
1, rue Montaigne
45380 La Chapelle St Mesmin
France

09 70 82 04 12 (Prix d'un appel local non inclus)
contact@info-premier.fr



N° de Lot:

NOTICE D'INSTRUCTIONS

RECOMMANDATIONS POUR UNE INSTALLATION OPTIMALE DES MITIGEURS LAVABO ET EVIER

1. PARTICULARITES :

- La cartouche céramique
 - Souplesse d'utilisation
 - Etanchéité totale
 - Débit constant
 - Silencieux

2. CARACTERISTIQUES TECHNIQUES :

- Mitigeur également adapté aux chauffe-eau à gaz
- Montage facile
- Convient pour une pression de 1 à 3 bars
- (La pression normale étant de 3 bars, si supérieure, veuillez installer un réducteur de pression)

3. UTILISATION :

- Nettoyer les tuyauteries en faisant couler beaucoup d'eau pour éliminer tous les corps étrangers tels que limaille, débris de soudure, sable, etc...
- Visser la tige filetée et les flexibles d'alimentation puis enfiler le joint de caoutchouc
- Poser le mitigeur sur l'évier ou sur le lavabo et enfiler, par dessous, la rondelle de caoutchouc et la bague de fixation à travers les tiges filetées
- Visser les écrous de serrage sur les tiges filetées pour fixer le mitigeur
- Ouvrir les arrivées d'eau et vérifier l'étanchéité de votre montage.
- Eviter de raccorder les tuyaux du mitigeur par soudage afin de ne pas endommager la cartouche céramique
- Lors de la pose, la pose de filtres facilitera l'entretien du mitigeur et évitera la présence de corps étrangers pouvant, également, endommager la cartouche céramique

→ NOUS CONSEILLONS D'ENTREtenir CETTE ROBINETTERIE AVEC UNE EAU SAVONNEUSE ET UN CHIFFON DOUX

TECHNICAL INSTRUCTIONS

RECOMMENDATIONS FOR OPTIMAL INSTALLATION OF OUR SINGLE SINK AND KITCHEN MIXERS

1. PARTICULARITIES

- The ceramic cartridge advantages:
- Use's flexibility
 - Total waterproof ness
 - Regular debit
 - Silent

2. TECHNICAL CHARACTERISTICS

- Single lever mixer available for gas heater
- Easy montage
- Suitable for a pressure of 1 to 3 bars
- As the normal pressure is 3 bars we suggest you to install a pressure's reducer in case of more pressure

3. USING

- Clean the arrival tubes with a lot of water's flow to eliminate all dirty parts like small metal particles, welding fragments, sand,
- Screw the metal shaft and the flexible hoses, then put the rubber joint
- Install the single level mixer on the sink or on the basin and put, under the sink or the basin, the rubber disc and the fixation ring along the metal shaft
- Screw the nut on the metal shaft to fix the single lever mixer
- Open water arrivals and check the total waterproof ness of your installation
- Please, don't assembly the mixer's hoses by welding to avoid any damage on the ceramic cartridge
- The filters' installation is recommended by installation and will avoid any dirty parts which can damage your ceramic cartridge